

6. Remote Control Operation

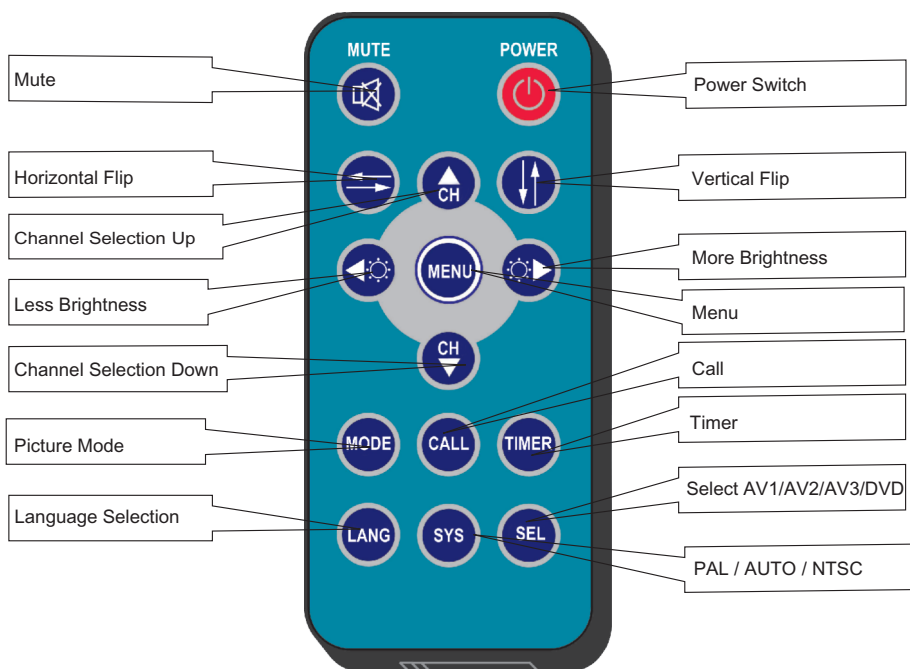

! Notice

1. Please align the remote control with the infrared-receiving window on the monitor to operate.
2. Never disassemble the remote control or allow it to drop, or become wet.
3. Press the control buttons firmly. Allow 2 seconds for the picture to change.

- **MUTE (Mute):**
Press to select ENABLE/MUTE sound.
- **POWER (Power Switch):**
Press to turn on/off the monitor.
- **↔ (Horizontal Turning of Picture):**
Press to turn picture horizontally.
- **↕ (Vertical Turning of Picture):**
Press to turn picture vertically.
- **CH+ (Channel Selection+):**
Press to select channel/item on menu.
- **CH- (Channel Selection-):**
Press to select channel/item on menu.
- **◀☉**
Press to decrease Brightness.
- **☉▶**
Press to increase Brightness.
- **MENU :**
Press to show menu.
- **MODE (Picture Mode):**
Press to select different picture modes (PERSONAL / STANDARD / SOFT / VIVID / LIGHT).
- **CALL (Call):**
Press to close menu.
- **TIMER:**
Press to set the timer to shut down the monitor (10,20,30,40 and max 90 minutes).
- **LANG(Language Selection):**
Press to select language display of ENGLISH , FRENCH, PORTUGUESE, SPANISH , RUSSIAN , GERMAN , ITALIAN or DUTCH options .
- **SYS:**
Press to select PAL / AUTO / NTSC.
- **SEL:**
Press to select AV channels.



7. Basic Operation

7.1. Connection of AV Input Cable

Align the small end of AV conversion adapter with the DVD jack on the front panel of the display. Then plug in. Connect the RCA connectors to the output signal of the video and/or audio of the DVD/ VCD player.



7.2. Connection of AV Adapter and Controller Cable

Hold the cable, align the side of jack marked with  on the female 13-pin connector with the male 13-pin connector marked with  then firmly plug together.



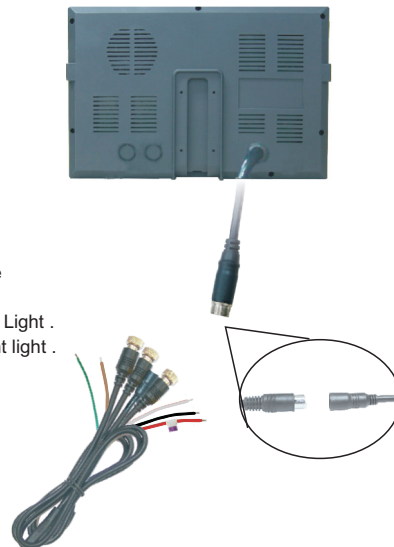



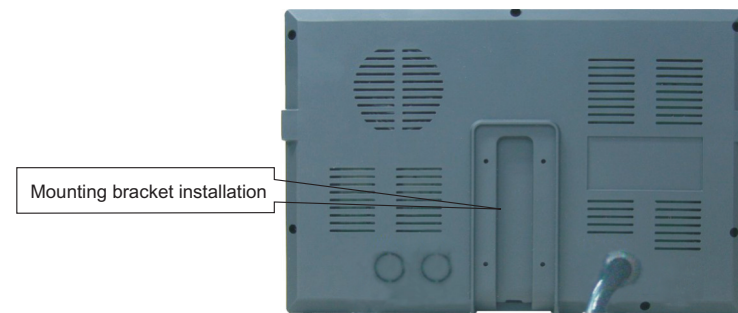
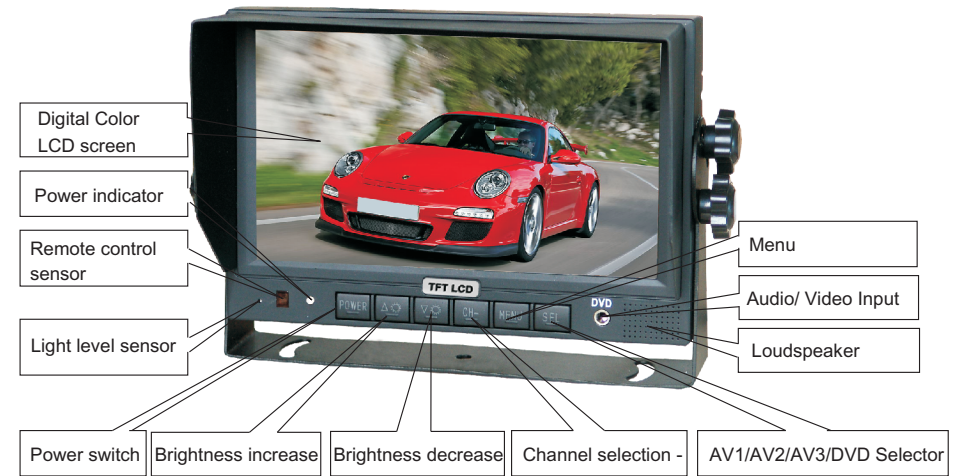

- ① Black 4 pin male for Camera1.
- ② Black 4 pin male for Camera 2.
- ③ Black 4 pin male for Camera 3.
- ④ Single red wire to power wire of DC / 10-32V.
- ⑤ Single black wire to GND.
- ⑥ Single brown wire to positive power wire of the back-up light.
- ⑦ Single white wire to positive power wire of left Light .
- ⑧ Single blue wire to positive power wire of right light .



5. Parts Identification



4. Accessories

 <p>U- Support Bracket</p>	 <p>Center Mount Bracket</p>
 <p>AV and Power supply adapter cable</p>	 <p>IR Remote Control</p>
 <p>Sun Shield</p>	 <p>Detaching Piece</p>
 <p>Angle Adjustment screws</p>	 <p>Front Panel AV Input adapter</p>
 <p>Flush Mount(optional)</p>	

⚠ Special Notice

Accessory supply may be different for different application.

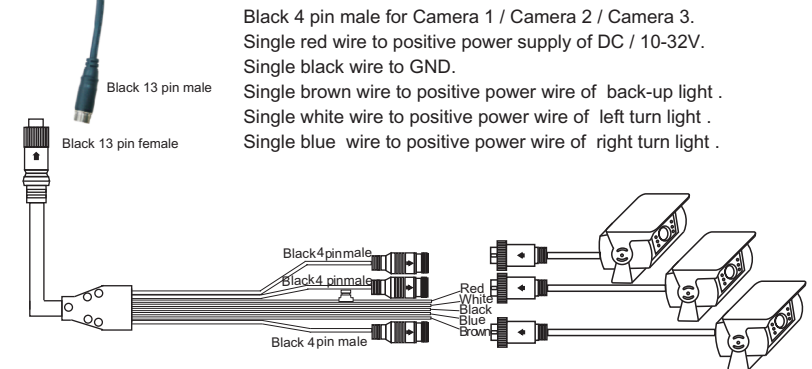

Black 4 pin male for Camera 1 / Camera 2 / Camera 3.
 Single red wire to positive power supply of DC / 10-32V.
 Single black wire to GND.
 Single brown wire to positive power wire of back-up light .
 Single white wire to positive power wire of left turn light .
 Single blue wire to positive power wire of right turn light .

7.3. Removing the Monitor:

7.3.1. Insert the detaching piece as indicated by the white arrow. Press in and lift up, the monitor will be released from the flush mount.

7.3.2. Remove the monitor.

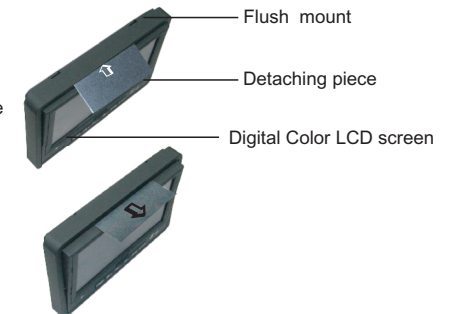

7.4.Reversing Display:

7.4.1. When the white wire is connected to the positive wire of the left turn light , the monitor automatically switches to CAM1 (left side camera) when the left turn indicator is activated.

CAM1

7.4.2. When the blue wire is connected to the positive wire of the right turn light , the monitor automatically switches to CAM 2 (right side camera) when the right turn indicator is activated.

CAM2

7.4.3. When the brown wire is connected to the positive wire of back-up light, the monitor automatically switches to CAM 3 (back-up camera) when the back-up light is turned on. The distancing grid will also be displayed.

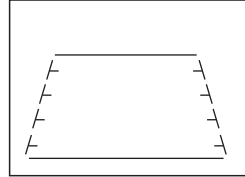

8. Menu

● Press MENU to display the following options and settings:

1. PICTURE
2. OPTION
3. SYSTEM

(1) Picture

BRIGHT, CONTRAST, COLOR, VOLUME options will display on the screen as illustrated below:

● Press CH- to select BRIGHT.

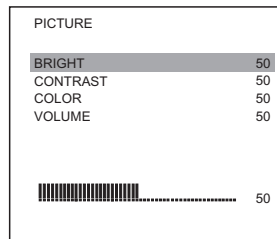

Press Δ / ∇ to adjust the brightness level.

2. Product Features

1. TFT LCD monitor with wide angle view and high resolution display.
2. Picture image may be adjusted for Horizontal, Vertical, Mirror and Normal viewing.
3. Select from 8 languages for user operation.
4. Automatic backlighting for buttons.
5. Mirror and Normal switch available.
6. Full-function remote control.
7. Multiple video formats available: PAL / AUTO / NTSC.
8. Up to 4 AV inputs. Three cameras input on the rear and one A/V input on the front panel.
9. Operates from DC / 10 - 32V. Supports 12V or 24V automobile battery.
10. Automatically switches to back-up, left or right side camera views.
11. On-board speaker.

3. Technical Specifications

1. 7" TFT- LCD Color monitor with digital panel.
2. Audio output: 1W.
3. Loudspeaker: one 15x24mm round loudspeaker.
4. Power supply: Automobile storage battery (10-32V).
5. Power consumption: about 6W .
6. Outer dimension: 182mm (W) × 122mm (H) × 26mm (T) (without flush mount),
198mm (W) × 138mm (H) × 31mm (T) (with flush mount).
7. Dot pitch: 0.192 (H) × 0.1805 (V).
8. Resolution: 800×3 (RGB) × 480.
9. Contrast: 500:1.
10. Brightness: 400cd/m².
11. Viewing angle: U: 50° / D: 60°, R/L: 70° / 70°.
12. Operating temperature: -20~+70°C, RH90%.
13. Storage temperature: -30~+80°C, RH90%.

Special Notice

All specifications are subject to change without notice.

● Maintenance

1. Remove all the cable connections from the monitor before cleaning the unit.
2. Use a mild household detergent and clean the unit with a slightly damp, soft cloth.
Never use strong solvents such as thinner or benzene, as they might damage the finish of the device.

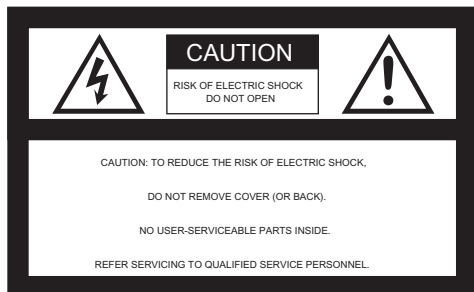

This symbol is intended to alert the user to the presence of uninsulated "dangerous voltage" within the product's enclosure that may be of sufficient magnitude to constitute risk of electric shock to persons.



This symbol is intended to alert the user to the presence of important operating and maintenance (servicing) instructions in the literature accompanying the appliance.



This symbol is intended to alert the user not to waste electrical and electronic equipment.

CAUTION

You are cautioned that any changes or modifications not expressly approved in this manual could void your warranty and necessitate expensive repairs.

● Declaration of conformity



This device complies with Part 15 of the FCC Rules. Operation is subject to the following two conditions:
(1) This device may not cause harmful interference.
(2) This device must accept any interference received, including interference that may cause undesired operation.



● Press CH- to select CONTRAST.

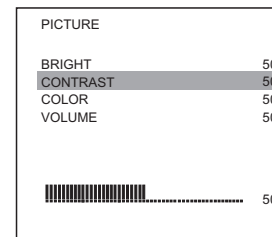

Press Δ / ∇ to adjust the contrast level.

(2) OPTION

LANG , SCALE , CAM1 , CAM2 , CAM3 , DVD options display on the screen as illustrated below :

● Press CH- to select LANG.

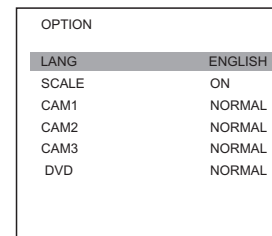

Press Δ / ∇ to select ENGLISH / FRENCH / PORTUGUESE / SPANISH / RUSSIAN / GERMAN / ITALIAN / DUTCH.

● Press CH- to select SCALE.

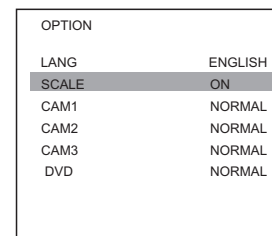

Press Δ / ∇ to select ON / OFF. Scale refers to the reversing distance indicator displayed on the monitor.

- Press CH- to select CAM1.

OPTION	
LANG	ENGLISH
SCALE	ON
CAM1	NORMAL
CAM2	NORMAL
CAM3	NORMAL
DVD	NORMAL

Press / to select NORMAL / MIRROR.

(3) System

COLOR-SYS, BLUE BACK, HORIZONTAL, VERTICAL, ZOOM functions will display on the screen as illustrated below :

- Press CH- to select COLOR-SYS .

SYSTEM	
COLOR-SYS	AUTO
BLUE BACK	ON
HORIZONTAL	↕
VERTICAL	↕↕
ZOOM	16:9

Press / to select PAL / AUTO / NTSC.

- Press CH- to select BLUE BACK.

SYSTEM	
COLOR-SYS	AUTO
BLUE BACK	ON
HORIZONTAL	↕
VERTICAL	↕↕
ZOOM	16:9

Press / to select ON / OFF.

1. Precautions

- Storage and Keeping

1. Do not expose the monitor to excessive heat or cold. The storage temperature of this device is -30~+80°C, and the operating temperature is -20~+70 °C. The humidity is Rh90%.
2. Never use this device near a bathtub, wash basin, kitchen, damp basement, swimming pool or similar places.
3. Never use this device in environments with excessive moisture, dust or smoke.
4. Avoid dropping or striking this device.
5. Avoid using this device in enclosed spaces, areas with excessive vibration or subject to severe impacts.
6. Never puncture, scratch or use abrasive cleaning materials on this device..
7. Do not place cables where they may be pinched or stepped on.
8. Leave at least a 2" space between the monitor and walls, cabinets or other objects to allow adequate air circulation around the unit.
9. The monitor is not designed to be waterproof.

- Operating Precautions

1. The device may be powered by a 12 or 24 volt automotive battery or vehicle electrical system
2. Make sure all cables are connected properly. Observe polarity. Improper cable connections may damage the monitor. Remove the power cable connections when you do not intend to use the unit.

Warning!

1. High voltage is present within the monitor. The opening of the case should be by professionals.
2. Do not watch the video while driving unless you are monitoring the rear view camera display.

Special Notice

Occasionally, a few highlights or dark spots may occur on the LCD screen. This is a very common phenomenon in active matrix display technology, and doesn't necessarily indicate any defects or faults. Never try to repair this device by yourself. In case of any problems, please turn off the display at once and notify our company or authorized dealer. The monitor is a complex device. Any disassembly or modification may lead to damage and void the warranty.

- Press CH- to select ZOOM.

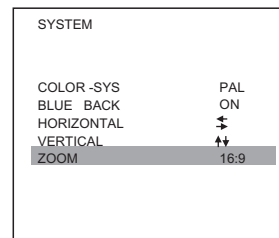

Press Δ / ∇ to select 16:9 or 4:3.

9. Troubleshooting

The symptoms described below do not necessarily mean a failure within the display. Please check the following items before you initiate request for repair.

Symptom	Possible Causes/Solutions
No picture, no sound	Improper connection of automobile adapter. Use of unauthorized power supply. Power switch is on OFF position.
No picture	Check whether AV cable is properly connected.
No sound	Check whether audio wire is properly connected or the sound volume is turned off or set too low.
Dark picture	Check whether brightness and contrast are adjusted correctly; Check whether the environments temperature is too low.
No color	Adjust the color settings.
Upside down or lateral inverted picture	Use the remote control horizontal /vertical selection switch to set proper orientation
No reversing function (i.e. Picture)	The black wire of the monitor AV cable to the reversing light may be loose. The red wire from the monitor may be loose.

Contents

1. Precautions	1
2. Features	3
3. Technical Specifications	3
4. Accessories	4
5. Parts Identification	5
6. Remote Control Operation	6
7. Basic Operation	8
8. Menu	10
(1) Picture	10
(2) Option	11
(3) System	12
9. Troubleshooting	14

Operating Instructions



Digital LCD Color Monitor

Please read this manual thoroughly before operating the unit,
and keep it for future reference.

V2.3